



INTERCON

FURNITURE FOR LIFE





ASSEMBLY INSTRUCTION

DESCRIPTION: REGIS DUAL POWER RECLINER SOFA W/DROP

ITEM NO: RS-SF-388DPR-BCH-C

Thank you for purchasing this quality product. Be sure to check all packing material carefully for small parts which may have come loose inside the carton during shipment. Identify and count all parts and compare with the parts list below. Please keep all hardware out of reach of small children.

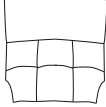
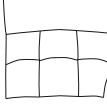
NOTE: Do not use power tools for assembly. Power tools increase the risk of over tightening which lead to splitting or cracking the wood.

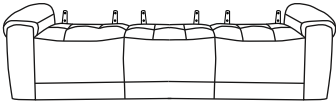
<p>A</p>  <p>LEFT EAR (x1)</p>	<p>B</p>  <p>RIGHT EAR (x1)</p>	<p>C</p>  <p>BACK REST (x1)</p>	<p>D</p>  <p>RIGHT BACK REST (x1)</p>	<p>E</p>  <p>MIDDLE BACK REST (x1)</p>	<p>F</p>  <p>SEAT</p>
---	--	--	--	---	---

Please follow the drawings below to assemble the item:

Step 1. Insert the left backrests (C) right backrests (D) and middle backrests (E) to the seat (F) and make sure all the backrests are secured in position.

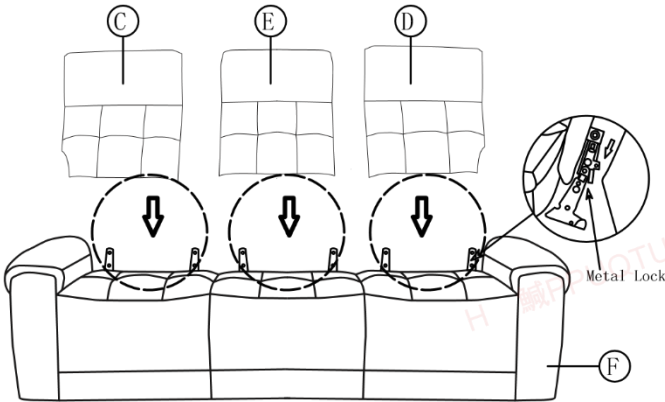

Step 2. Insert the left ears (A) & right ears (B) into backrest and make sure the ears are secured in position.

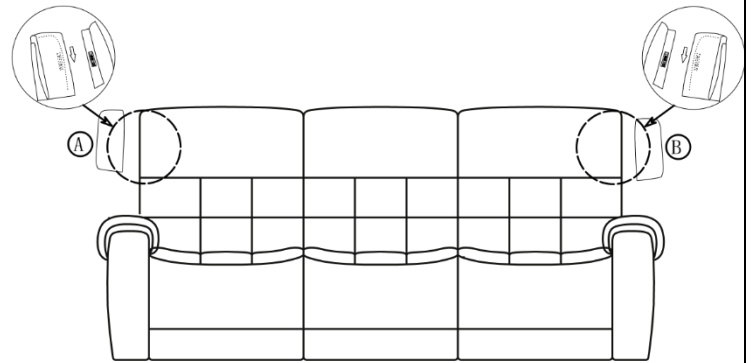

Step 3. Connecting Power Cord

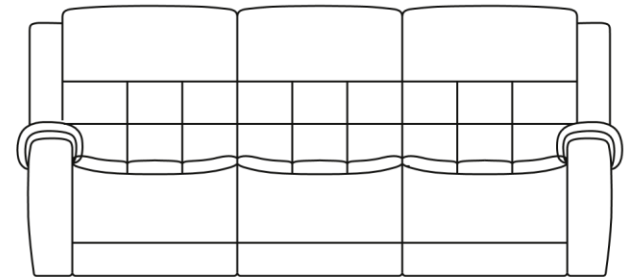
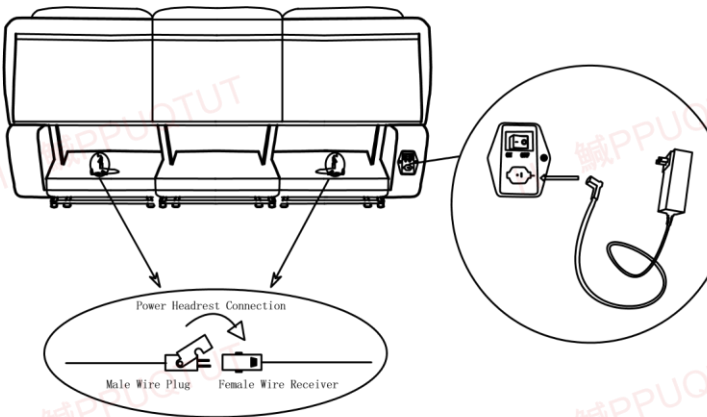

Complete Assembly

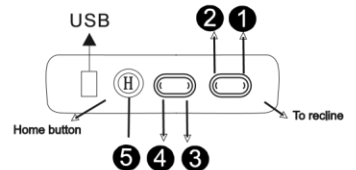

Operation Instructions:

1. Press button 1 to recline the chair to desired position.
2. Press button 2 to raise the chair to the upright position.
3. Press button 3 to activate the headrest forward.
4. Press button 4 to return headrest to the closed position.
5. Press button 5 Home button returns both footrest and headrest to the original upright/closed position.

CARE INSTRUCTION FOR LEATHER / FABRIC FURNITURE:

- Avoid exposing furniture directly with sunlight or heating and air conditioning outlets.
- Exposure to sunlight or heating and air conditioning outlets will fade/damage leather / fabric.
- Wipe gently with a damp soft cloth to remove dust, dirt and any buildup.
- Wipe the leather with professional cleanser.