









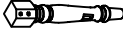

INTERCON
FURNITURE FOR LIFE

ASSEMBLY INSTRUCTION

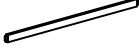
DESCRIPTION: 46" Backless Bench w/Cushion

ITEM NO: BI-CH-4615B-RDO-RTA

Thank you for purchasing this quality product. Be sure to check all packing material carefully for small parts which may have come loose inside the carton during shipment. Identify and count all parts and compare with the parts list below. Please keep all hardware out of reach of small children.

| | | | | | | | |
|---|---|---|--|---|--|--|--|
| <p>A</p>  <p>CUSHION SEAT 1 PC</p> | <p>B</p>  <p>FRONT LEG- LEFT 2 PCS</p> | <p>C</p>  <p>FRONT LEG- RIGHT 2 PCS</p> | <p>D</p>  <p>SIDE STRETCHER 2 PCS</p> | <p>E</p>  <p>MIDDLE STRETCHER 1 PC</p> | | | |
| <p>1</p>  <p>ALLEN BOLT Ø 5/16" x 64mm 8 PCS</p> | <p>2</p>  <p>SPRING WASHER Ø 5/16" 8 PCS</p> | <p>3</p>  <p>FLAT WASHER Ø 5/16" 8 PCS</p> | <p>4</p>  <p>SCREW 45mm 6 PCS</p> | <p>5</p>  <p>ALLEN KEY M4 1 PC</p> | | | |

STEP 1

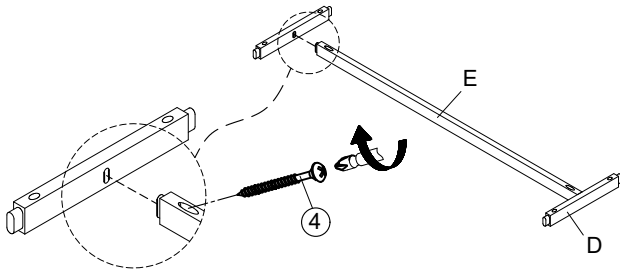

STEP 2

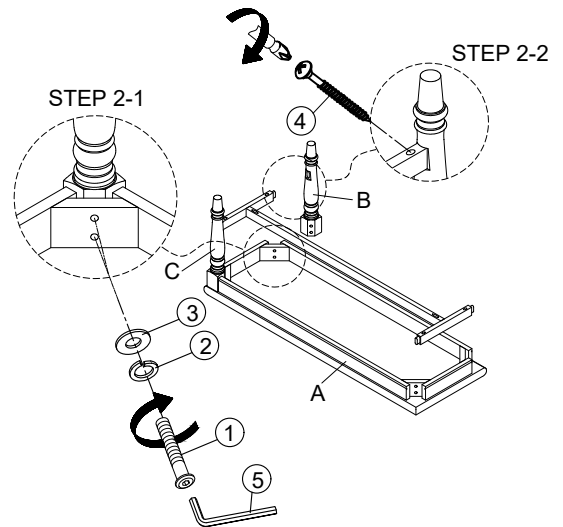

STEP 3

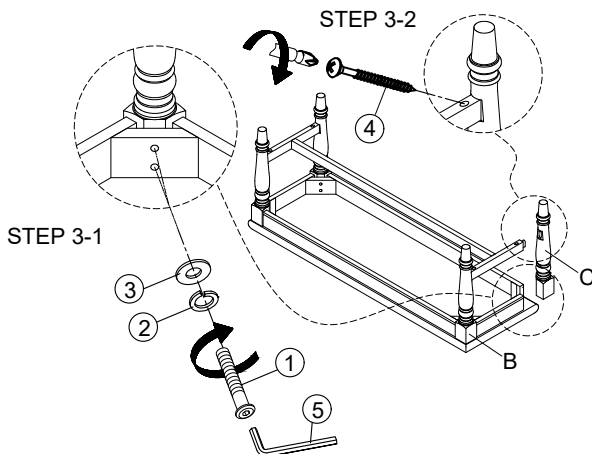

STEP 4

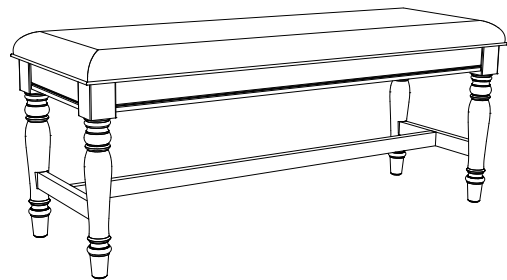

COMPLETE ASSEMBLY

ASSEMBLY TIPS:

1. Remove hardware from box and sort by size.
2. Please check to see that all hardware and parts are present prior start of assembly.
3. Please follow attached instructions in the same sequence as numbered to assure fast and easy assembly.

⚠ WARNING!

1. Don't attempt to repair or modify parts that are broken or defective. Please contact the store immediately.
2. This product is for home use only and not intended for commercial establishments.