



**INTERCON**  
FURNITURE FOR LIFE



# ASSEMBLY INSTRUCTION

DESCRIPTION: HYDE PARK POWER RECLINING LOVE SEAT

ITEM NO: HK-LS-268PR-TOB-C

Thank you for purchasing this quality product. Be sure to check all packing material carefully for small parts which may have come loose inside the carton during shipment. Identify and count all parts and compare with the parts list below. Please keep all hardware out of reach of small children.

NOTE: Do not use power tools for assembly. Power tools increase the risk of over tightening which lead to splitting or cracking the wood.

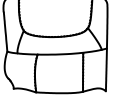
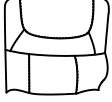
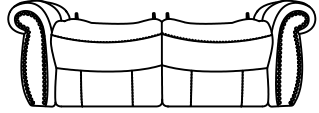
<p>A</p>  <p>LEFT EAR ( x1 )</p>	<p>B</p>  <p>RIGHT EAR ( x1 )</p>	<p>C</p>  <p>LEFT BACK REST ( x1 )</p>	<p>D</p>  <p>RIGHT BACK REST ( x1 )</p>	<p>E</p>  <p>SEAT ( x1 )</p>
---	--	---	--	--

Please follow the drawings below to assemble the item:

Step 1. Insert the left backrests ( C ) and right backrest ( D ) to the seat ( E ) and make sure the backrests are secured in position.

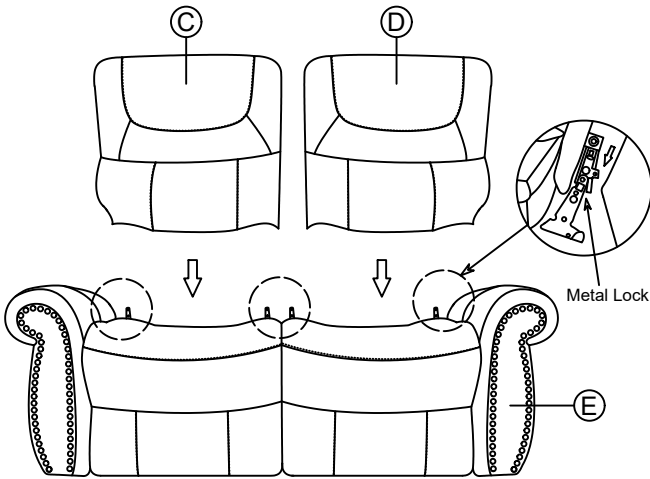

Step 2. Insert the left ears ( A ) & right ears ( B ) into the backrest and make sure the ears are secured in position.

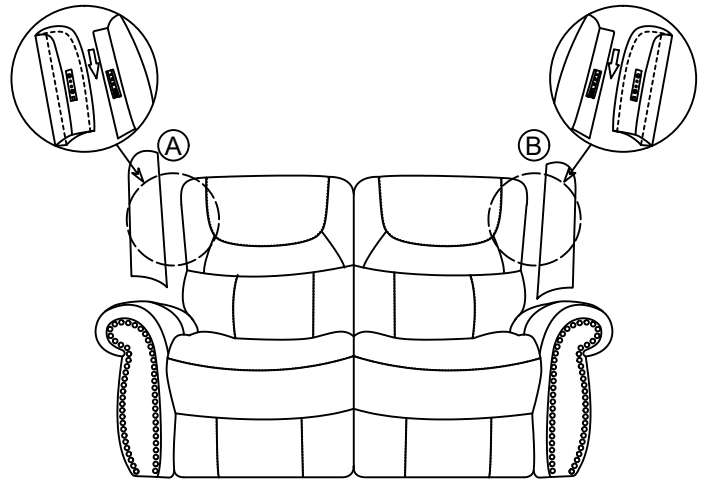

Step 3.  
Connecting Power Cord

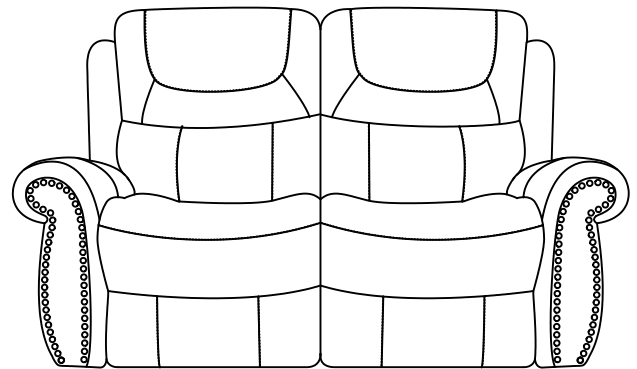
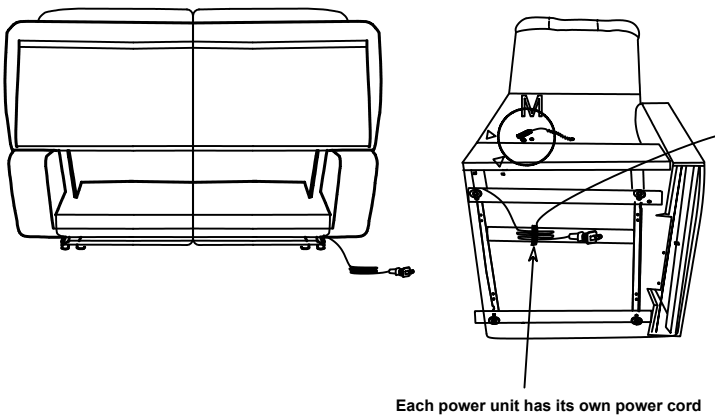

**Complete Assembly**

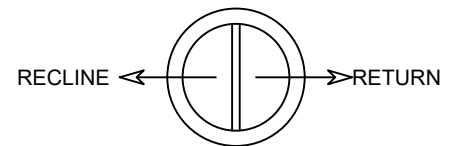

Operation Instructions:

1. Home Button: Press and hold this button at any time to return seating to original closed position.
2. To Operate Recline System: Press and hold back button to desired Recline position and personal comfort. Press and hold forward to close or adjust.

**CARE INSTRUCTION FOR LEATHER / FABRIC FURNITURE:**

- Avoid exposing furniture directly with sunlight or heating and air conditioning outlets.
- Exposure to sunlight or heating and air conditioning outlets will fade/damage leather / fabric.
- Wipe gently with a damp soft cloth to remove dust, dirt and any buildup.
- Wipe the leather with professional cleanser.